

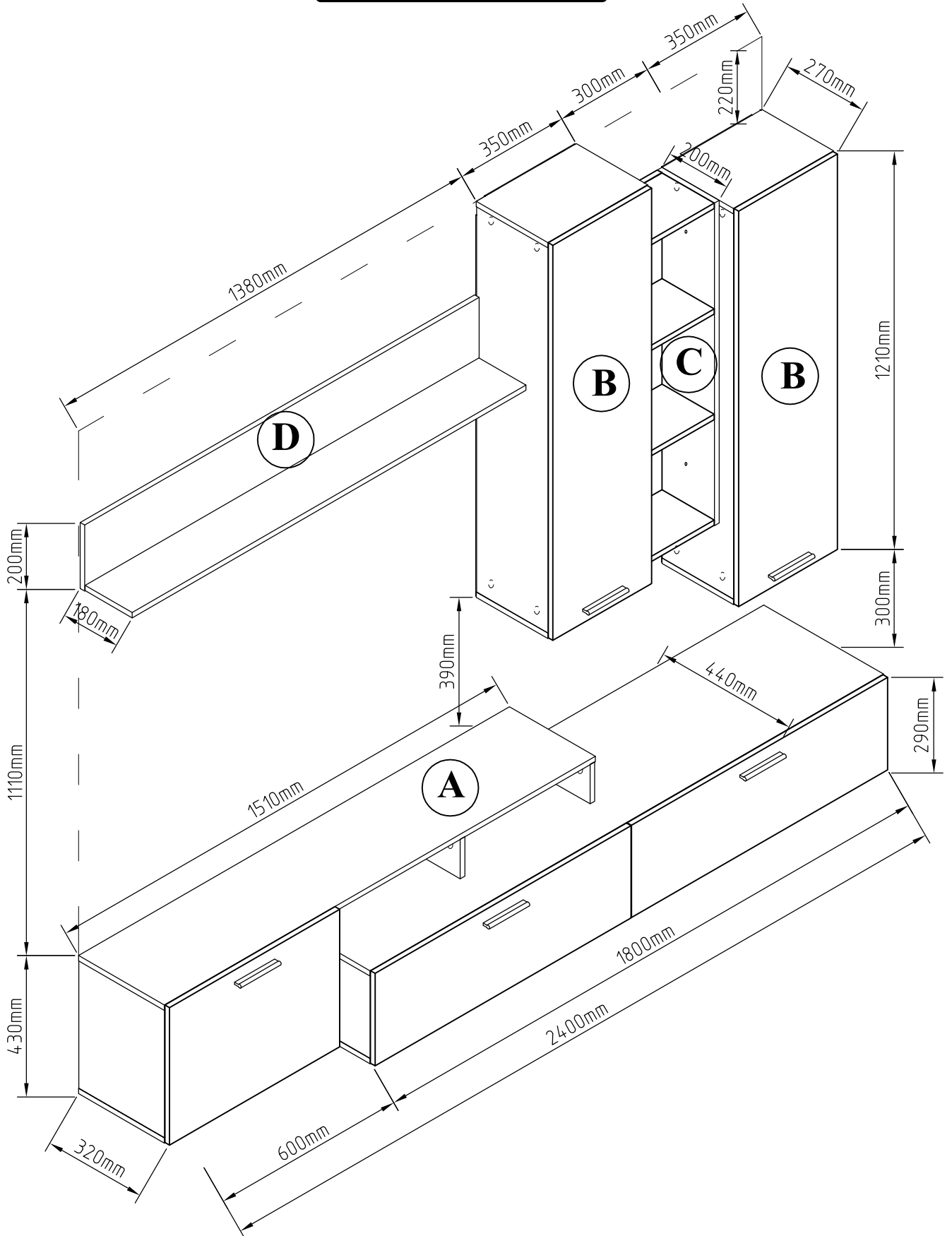

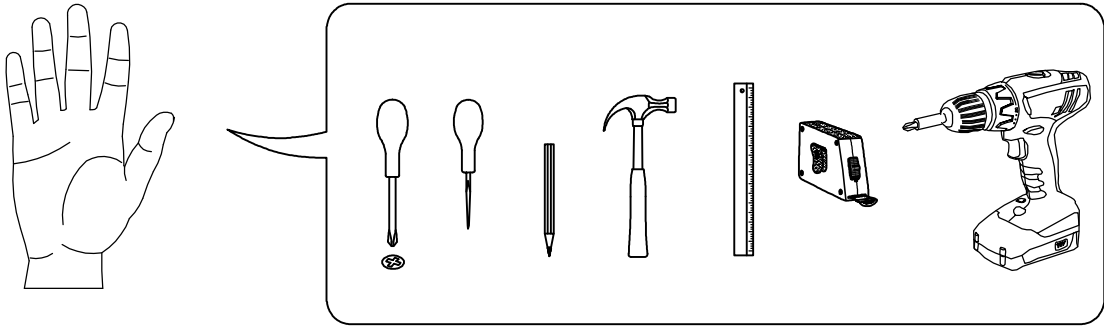

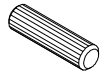





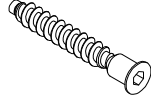
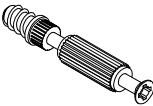





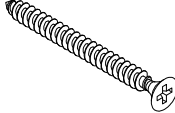

LORA

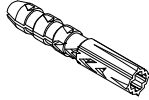
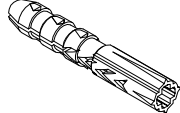

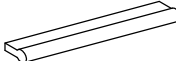
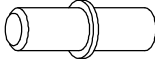
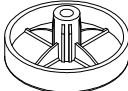
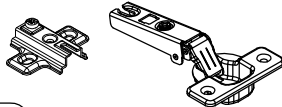
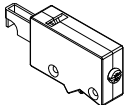

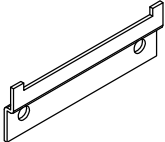
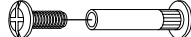
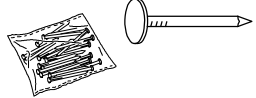
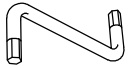
 (A1) 8*30mm x52	 (B) x34	 (B1) 6,3*50mm x34
 (C1) 6*43mm x30	 (D) ϕ 20mm x30	 (D1) 15/16 x30
 (E6) 3,5*16mm x44	 (E14) 4*25mm x10	 (E15) 4*30mm x4
 (E25) 6*60mm x4	 (E-5) 4,2*65mm x2	 (F1) 5,0*9mm x4
 (F4) 6,3*13mm x24	 (H5) 8*50mm x2	 (H6) 10*50mm x4
 (H14) x2	 (I9) x5	 (J1) 5*16mm x16
 (K5) x10	 (L1) x12	 (N1) x2
 (N12) x4	 (O4) x2	 (Q11) M 4 x6

 R3 1.4*25mm 0.080kg	 R4 N°4 x1	 U3 x10

A

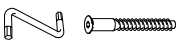
№	a*b	x	N°→...
1L	386x300	x1	2/4
1R	386x300	x1	2/4
2L	250x420	x1	1/4
2R	250x420	x2	3/4
3	120x298	x2	2/4
4	1508x300	x1	2/4
5	1798x420	x1	1/4
6	600x300	x1	2/4
7	1798x420	x1	1/4
8	596x416	x1	1/4
9	896x280	x2	3/4
10	595x415	x1	1/4
11	896x279	x2	1/4
		x1	4/4

B

No	a*b	x	N ^p →...
1L	1168x250	x2	4/4
1R	1168x250	x2	4/4
2	350x250	x4	4/4
3	315x240	x4	4/4
4	1198x346	x2	3/4
5L	1197x345	x1	3/4
5R	1197x345	x1	3/4

C

No	a*b	x	N ^p →...
1	978x200	x2	1/4
2	268x183	x4	3/4
3	268x978	x1	2/4

D

No	a*b	x	N ^p →...
1	1380x200	x1	1/4
2	1378x165	x1	1/4

A

LORA

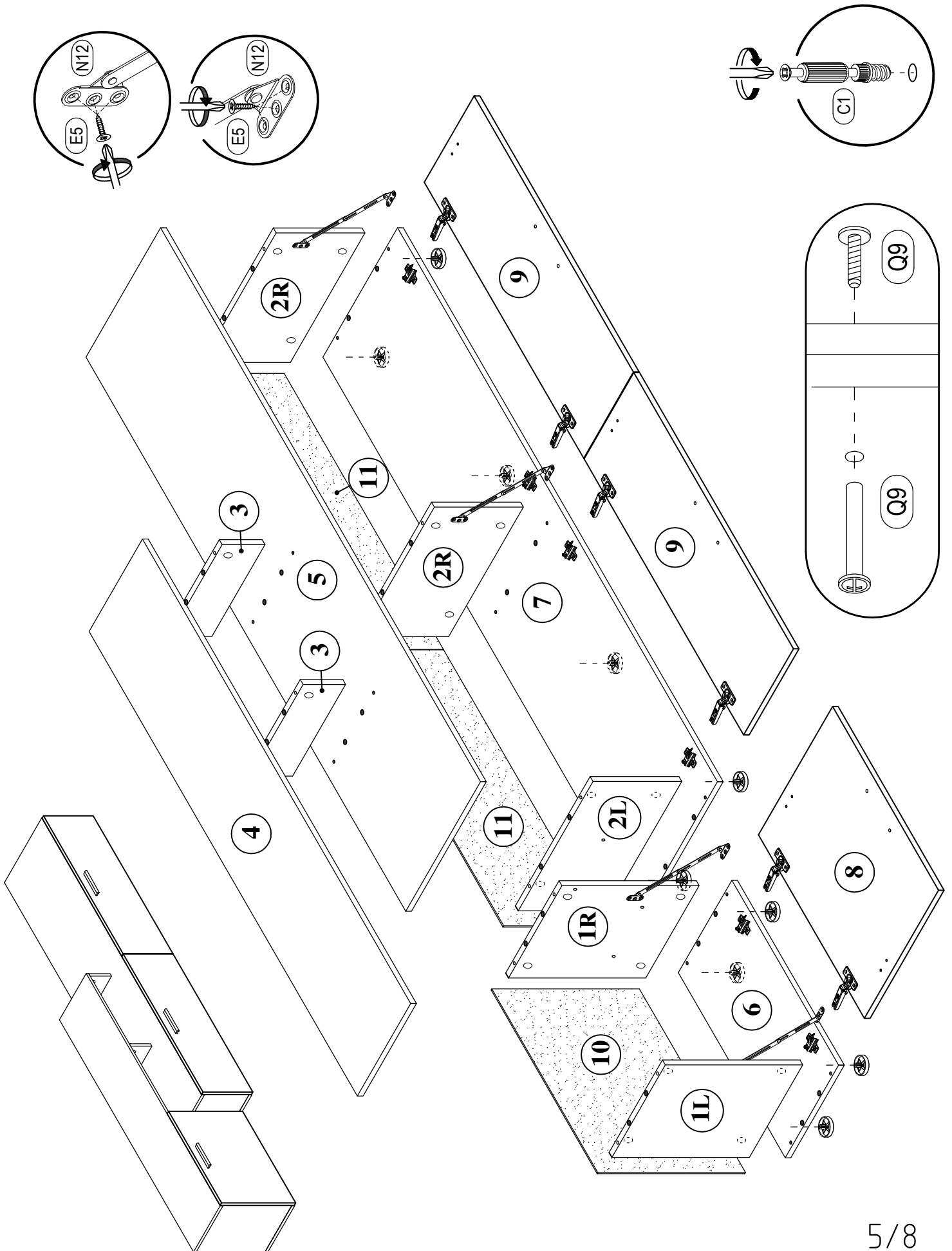

B

LORA

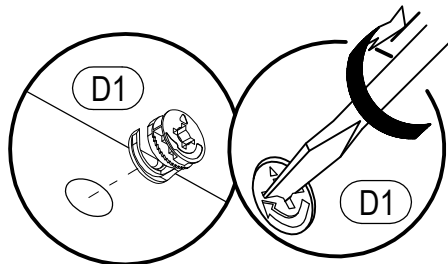
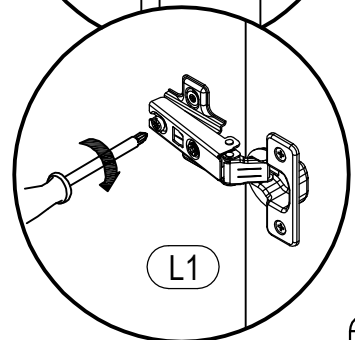
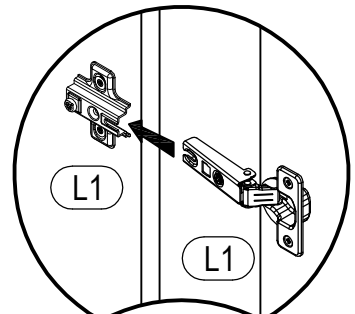
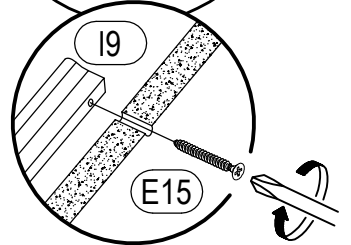
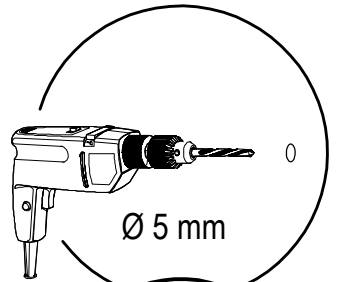
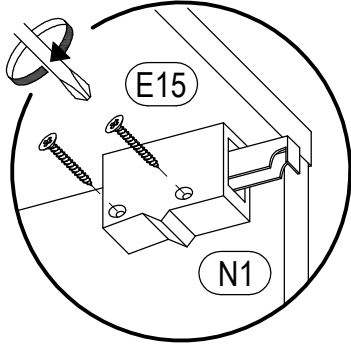
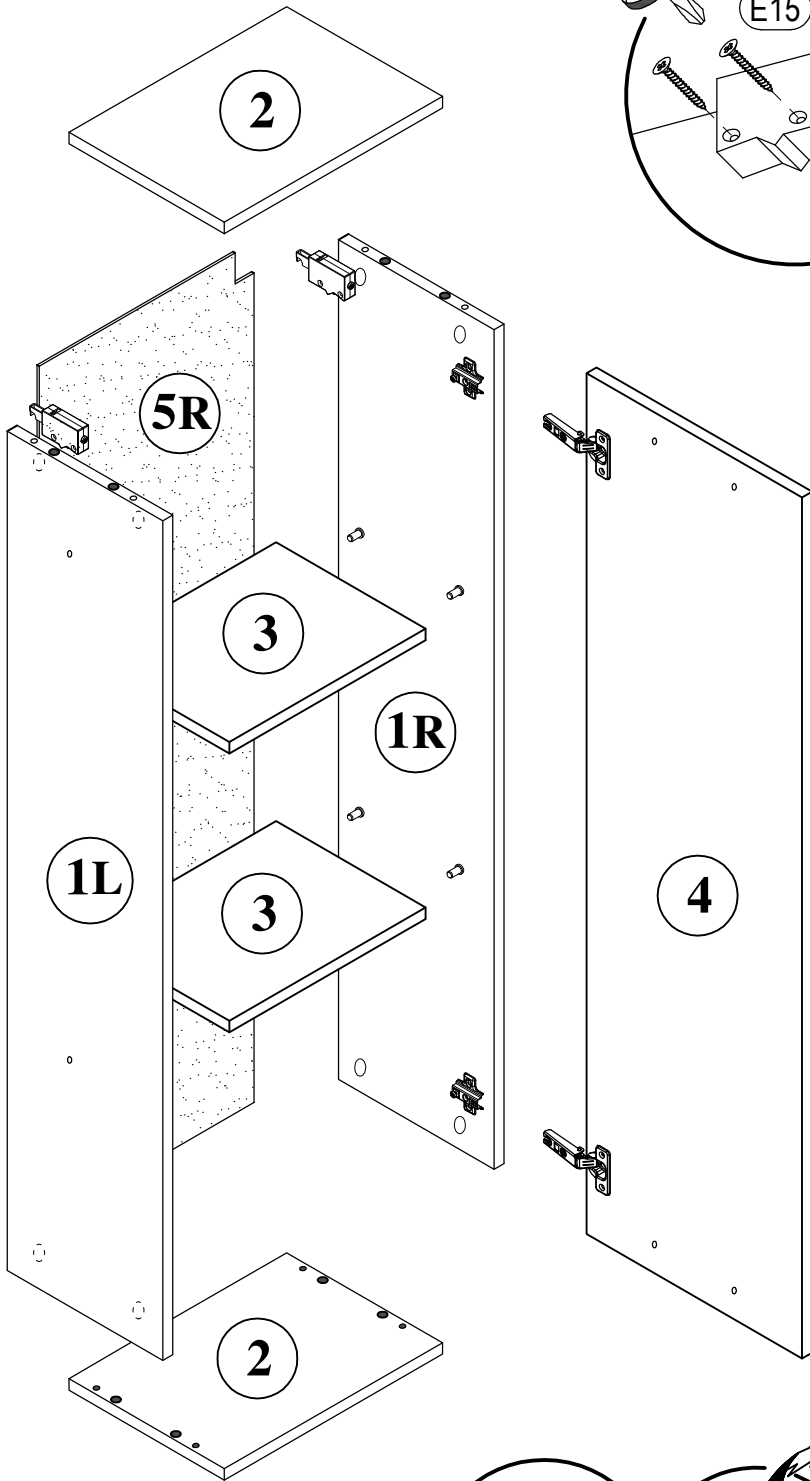
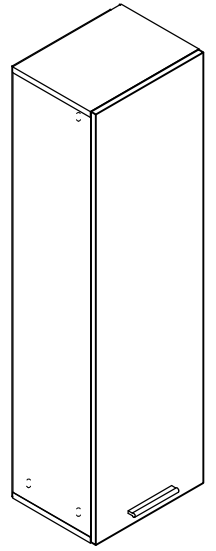

C

LORA

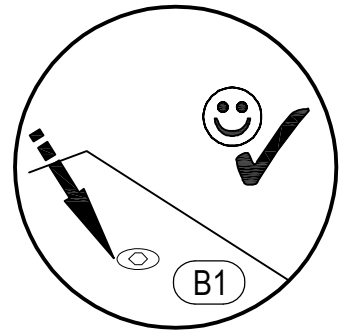
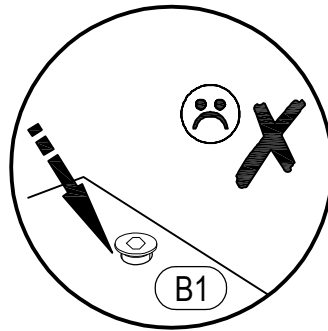
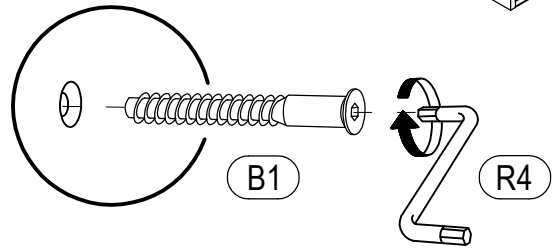
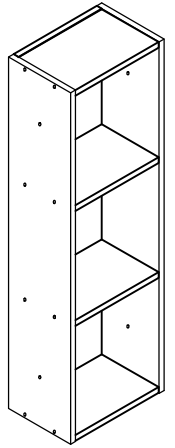
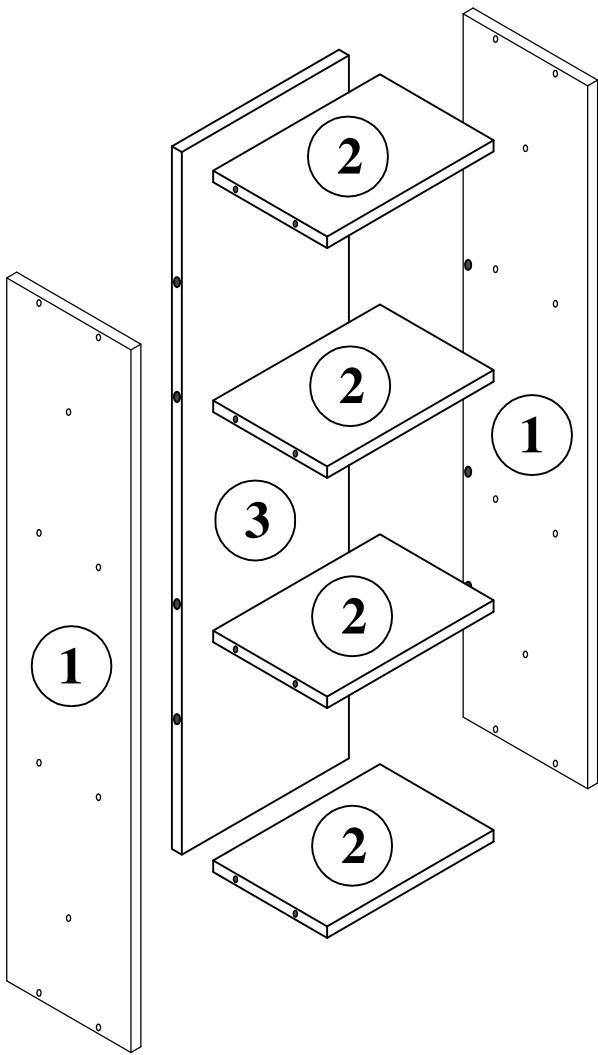

D

